

## X0SL23B ADVENTURE TANK BAG-BASE

### COMPONENTS

**(A)** RAIN COVER X1

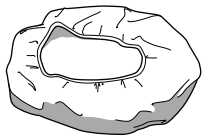

**(B)** UNIVERSAL BASE TANK X1

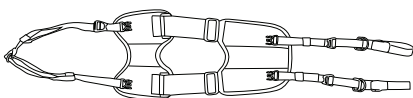

**(C)** SHOULDER STRAP X1

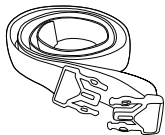

### FEATURES

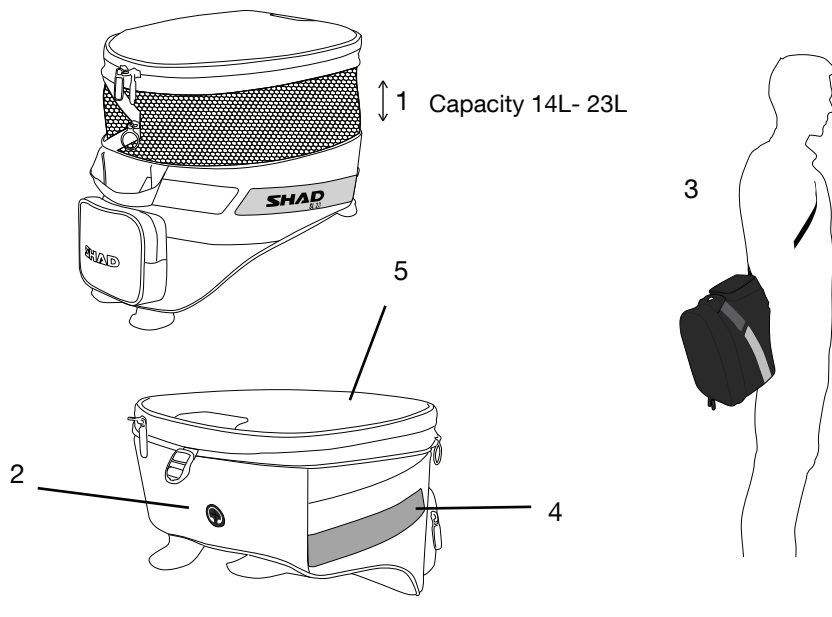

	Expandable	1
	Outlet for USB Charger	2
	Shoulder Strap	3
	Reflector	4
	Touch Screen	5
	Full Face Helmet Capacity	6
	Rain Cover	7
	Padlock Zipper Slider	8
	Universal Base Tank	9

### ⚠ WARNING

Clean the tank of the bike before placing the base (or the optional magnets) to avoid scratches in the paint.

Make sure the bag and its accessories are properly assembled.

To clean the bag use a damp cloth with neutral soap. Never use solvents or chemical products.

Prolonged exposure to the elements might discolor fabrics and wear away plastic components.

Waterproof zippers and rain covers do not guarantee that the bag is totally waterproof.

Use zippers with care. To open the bag slide zip all the way without forcing.

Maximum load: 2 Kg.

Maximum speed: 120 km/h or 74 mph.

SHAD will not hold responsibility for damages caused by an incorrect assembly.

### ⚠ PRECAUCIÓN

Limpiar el depósito de la moto antes de posicionar los imanes (o base universal opcional) para evitar rayadas en la pintura.

Asegurarse que la bolsa y todos sus accesorios están correctamente montados. Siempre hacer uso de la correa de seguridad.

Si requiere limpiar las bolsas utilice un paño húmedo con jabón neutro, nunca utilice disolventes o productos químicos.

La exposición prolongada a la intemperie puede ocasionar cambios en el color de tejidos y desgaste de componentes plásticos.

Los forros de lluvia no garantizan la completa impermeabilidad de la bolsa.

Utilizar las cremalleras con cuidado. Para abrir, deslizarlas hasta el final sin forzarlas.

Capacidad de carga: 2 Kg. máximo.

La velocidad máxima 120 Km/h / 74 Mph

SHAD no se hará responsable de los daños causados por un incorrecto montaje.

### ⚠ PRECAUTIONS

Nettoyez le réservoir de la moto avant de placer la base universelle (ou aimants optionnel) pour empêcher de rayer la peinture.

Assurez-vous que le sac et tous ses accessoires sont montés correctement. Utilisez toujours la ceinture de sécurité.

Si vous avez besoin de nettoyer le sac, passez un drap humide avec un savon neutre. N'utilisez pas de dissolvants ou de produits chimiques.

Une exposition prolongée à l'air libre peut provoquer des changements dans la couleur du tissu et l'usure des composants en plastique.

La housse de pluie n'assure pas l'imperméabilité complète du sac.

Utilisez les fermetures doucement pour ouvrir, faites-les glisser jusqu'au fin sans forcer.

Capacité: 2 kg au maximum.

La vitesse de la moto avec un sac devrait être d'un maximum de 120 km/h / 74 mph

SHAD ne sera pas responsable des dommages causés par un montage incorrect.

# MOTO FIXATION

Universal Base Tank  
Ref: X1SL90

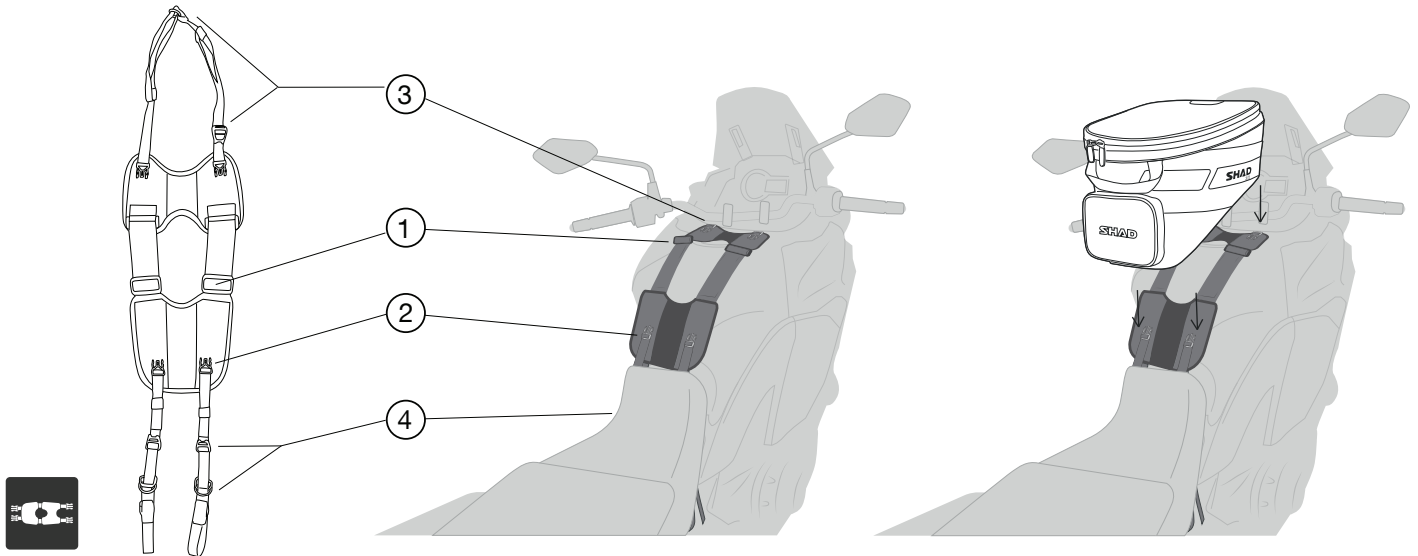

## ACCESSORIES NOT INCLUDED - SOLD SEPARATELY

USB Universal  
Moto Charger  
Ref: X1SB95

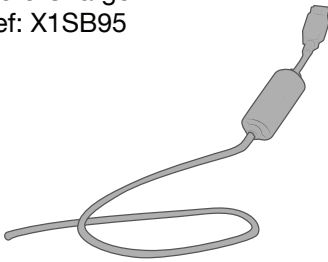

Magnets system  
Ref: X1SL11

Magnets x4



Security Strap x1

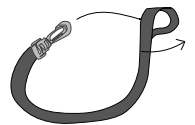

## MORE PRODUCT FROM SHAD



reddot design award  
winner 2015



MOTOR CASES



SOFT BAGS



COMFORT SEATS



ATV LUGGAGE



WWW.SHAD.ES