

SHAD

VOGE 500 DS '20 - / DSX '21 -

V0DS504P

4P
SYSTEM

BCN

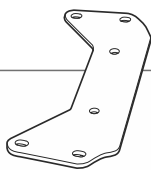

1 262695 x 1



2 260493 x 2
Ø20 - 12 Ø8,5 x 14-3



3 260686 x 2
Ø16 Ø9 x 8



4 303027 x 2
Ø8



5 303045 x 14
Ø8

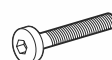

6 304169 x 2
M8x50 DIN 7380

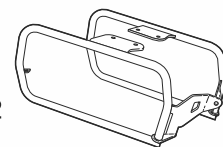

7 263014 x 1 →
263015 x 1 ←



8 304028 x 6
M8x25 DIN 7380



9 302024 x 6
M8



10 263016 x 1



11 304052 x 2
M6x20 DIN 7380



12 302021 x 2
M6



13 303017 x 4
Ø6

WARNING!

GB Do not fully tighten the screws until it is ensured that the KIT is correctly attached and aligned.

E No apretar los tornillos del todo hasta asegurarse que el KIT está correctamente colocado y alineado.

D Ziehen Sie die Schrauben nicht ganz fest, bevor Sie sich nicht vergewissert haben, daß der Bausatz korrekt eingestellt und ausgerichtet ist.

I Non stringere del tutto le viti fin tanto non si è sicuri che il kit è collocato correttamente e allineato.

F Ne pas serrer les vis avant d'être sûr que le KIT soit correctement positionné et ajusté.

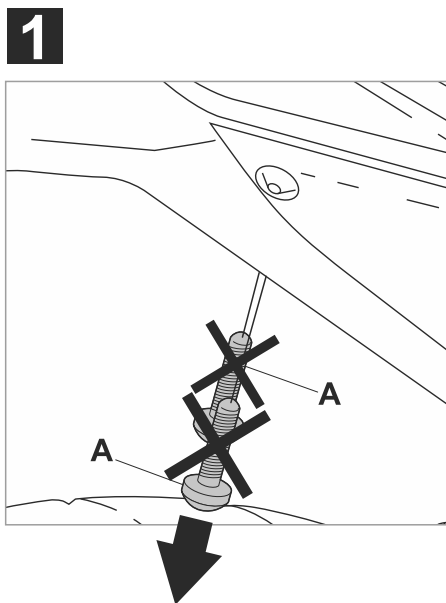

2

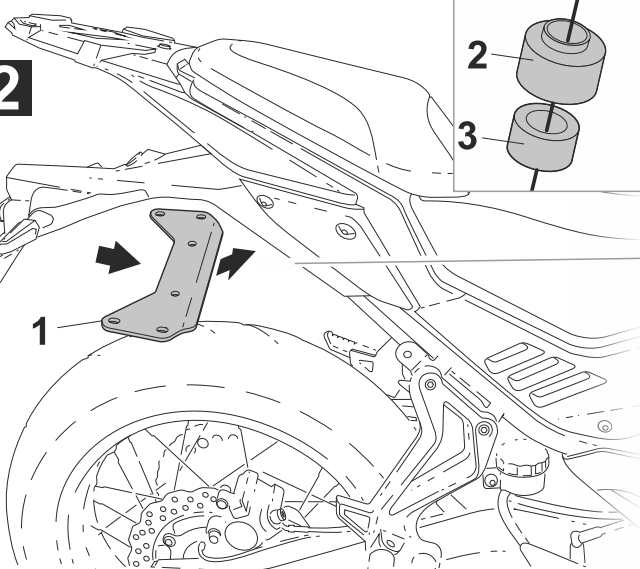

3

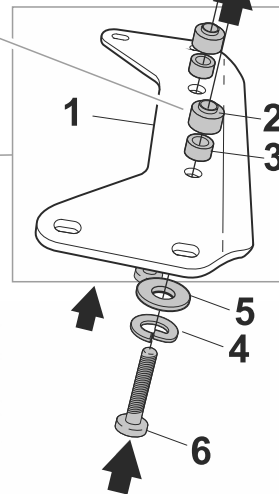

4

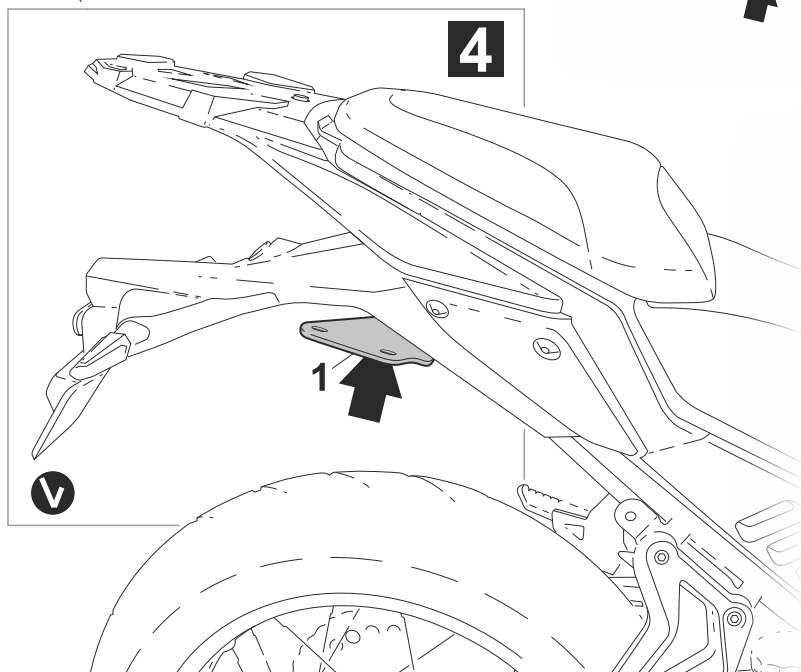

5

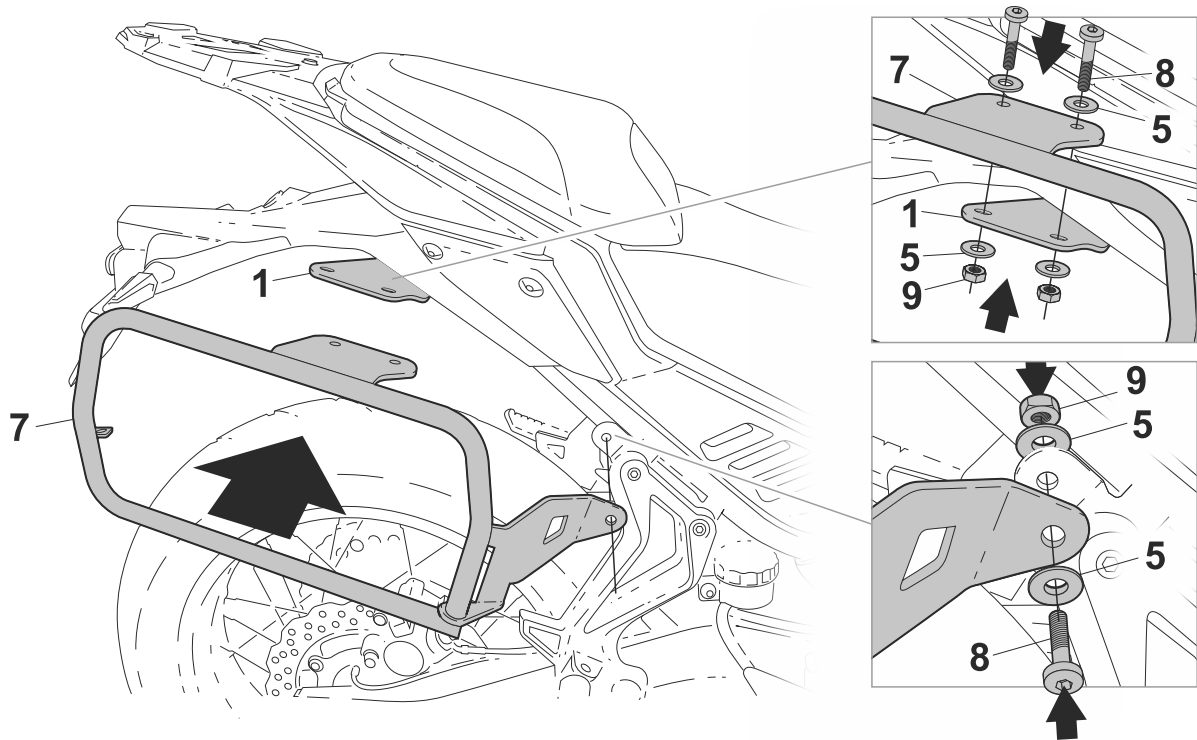

6

